



A New Simulation Model for Design of Distillation Column in a Bio-ethanol/Water System: Effect of Reflux Ratio

**A. E. Adeleke^{1*}, P. O. Aiyedun², M. A. Waheed², L. O. Sanni³,
S. O. A. Olawale⁴ and O. U. Dairo⁵**

¹*Department of Mechanical Engineering, Osun State University, Osogbo, Nigeria.*

²*Department of Mechanical Engineering, Federal University of Agriculture, Abeokuta, Nigeria.*

³*Department of Food Science and Tech, Federal University of Agriculture, Abeokuta, Nigeria.*

⁴*Department of Civil Engineering, Osun State University, Osogbo, Nigeria.*

⁵*Department of Agricultural Engineering, Federal University of Agriculture, Abeokuta, Nigeria.*

Authors' contributions

This work was carried out in collaboration between all authors. Author AEA designed the study, author POA and MAW wrote the protocol, and author AEA wrote the first draft of the manuscript. Author LOS supplied information on the properties of cassava mash. Author SOAO developed the software and author OUD performed the statistical analysis. All authors read and approved the final manuscript.

Research Article

Received 4th December 2012
Accepted 7th March 2013
Published 5th April 2013

ABSTRACT

Fuel ethanol research development deals with process design integration for improving production of ethanol. This paper investigates the effect of variable reflux ratio on the design of distillation column using developed JAVA based simulation software. This was done by varying reflux ratio as an input parameter and observed the effect it has on the number of trays that produced the column height. Varying reflux ratio arbitrarily from 3.094 to 9.301 produced column height ranging between 5.897 and 6.232 respectively. With the feed composition of ethanol-water mixture set at 45 percent, and the minimum reflux ratio of 3.4. The results showed that the number of trays decreases with increase in reflux ratio

*Corresponding author: E-mail: ezraademola@yahoo.com;

while the column height varies inversely with the reflux ratio.

Keywords: Fuel ethanol; reflux ratio; simulation; distillation column; process design; bio-ethanol/water system.

1. INTRODUCTION

The need for alternative energy has been on sharp increase in the recent past. This is due to increased instability in energy supply from oil producing regions of the world and the environmental impact associated with use of fossil fuel as energy source. It has therefore become necessary to source for alternative energy which is environmentally friendly, sustainable as well as reliable. One of such alternative energy source is the use of biofuels, which includes bioethanol [1,2,3]. Bioethanol is an alcohol made by fermenting the sugar components of plant materials and it is made mostly from sugar and starch crops such as sugarcane, corn, beet, cassava, wheat and sorghum. With advanced technology being developed, cellulosic biomass, such as trees and grasses, are also used as feed stocks for ethanol production. Ethanol can be used as a fuel for vehicles in its pure form, but it is usually used as a gasoline additive to increase octane and improve vehicle emissions. Fuel grade ethanol can wholly replace petroleum in modified vehicles [4]. Cassava (*Manihot esculenta*) is an excellent source of ethanol due to its high starch content. It is the most popular root crop in Sub-Sahara Africa. Oyewole [5] noted that the increasing potential of cassava as an individual crop has influenced the policy of the Federal Government of Nigeria in 2004 to embark on cassava multiplication program intended to supply fresh cassava roots and its product for the small and medium scale industrial uses and for exportation. To produce the bioethanol, it is necessary to separate ethanol from ethanol-water mixture after fermentation of alcohol. In practice, distillation is widely used for the separation [6] of this mixture therefore the distillation unit has to be design properly to enhance high purification. High purity of ethanol is required for efficient and effective utilization as gasoline fuel. Mechanical design of a distillation column of a bioethanol plant requires rigorous simulation of the process design for optimum parameters of which reflux ratio is of important. Industrial towers use reflux to achieve a more complete separation of products. Reflux refers to the portion of the condensed overhead liquid product from a distillation or fractionation tower that is returned to the upper part of the tower. Inside the tower, the down flowing reflux liquid provides cooling and condensation of the up flowing vapors thereby increasing the efficiency of the distillation tower. In existing designs, much has not been found in the literature on the effect of reflux ratio on the design of distillation column for bioethanol plant using cassava as feedstock. The purpose of this study is to investigate the effect of reflux ratio using a new simulation model for distillation column in a bio-ethanol/water system.

2. MATERIALS AND METHODS

2.1 Process Simulation

Process simulation is a model-based representation of chemical, physical, biological, energy producing and transforming, in addition to other technical processes and unit operations using software. The software has to solve the mass and energy balances, and find a stable operating point with optimal conditions for the process examined. Process simulation always uses models which introduce approximations and assumptions, but allow the description of a

property over a wide range of parameters which may not be covered by real data. Models also allow to interpolate or extrapolate, searching for conditions outside the range of known properties.

The process design software used for this work was developed using JAVA programming language hinged on McCabe - Thiele graphical method and Fenske equations to determine theoretical and actual number of stages involved in the distillation process. The process design parameters such as Reflux Ratio (R), Coefficient of Reflux (R_{Coeff}), mole fraction of the most volatile component in distillate (x_D), mole fraction of the most volatile component in bottom (x_B), mole fraction of the most volatile component in feed (x_F), Viscosity, thermodynamic property of feed (q) were simulated for optimum values through parametric process. Reflux ratio was then varied to give the mechanical design parameters (Number of trays and column height).

2.2 Distillation Columns

Distillation columns are made up of several components, each of which is used either to transfer heat energy or enhance material transfer. A typical distillation unit contains the following major components:

- i. A vertical Shell where the separation of liquid is carried out.
- ii. Column internals such as trays/plates and /or packing which are used to enhance component separations.
- iii. A reboiler to provide the necessary vaporization for the distillation process.
- iv. A condenser to cool and condense the vapour leaving the top of the column.
- v. A reflux drums to hold the condensed vapour from the top of the column so that liquid (reflux) can be recycled back to the column.

The vertical shell houses the column internals and together with the condenser and reboiler, constitutes a distillation unit as shown in Fig. 1. Also, the distillation column is divided into three sections (Rectifying, Stripping and feed) as shown in Fig. 2.

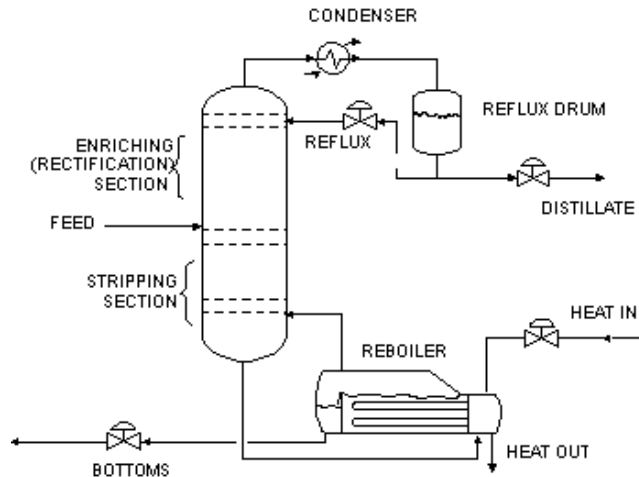

Fig. 1. Main components of distillation unit

2.2.1 Operation line

The general equation for a continuous binary distillation is given by Equation (1)

$$F x_F = B x_B + D x_D \tag{1}$$

Where; F, D, B are flowrates (kg.mol/hr) of feed, distillate, and waste or bottom, respectively. x_F, x_D, x_B are mole ratios of the most volatile components in feed, distillate, and the bottom respectively.

Given that x_n and L_n as the mole ratio and flowrate of the liquid phase flowing out of tray number n, counting from the overhead, and given y_{n+1} and V_{n+1} as component and flowrate of vapour rising up from tray number n+1, the operation line of the rectifying section called the Rectifying Section Operating Line (ROL) is given by Equation 2.

$$y_{n+1} = \frac{R}{(R+1)} x_n + \frac{1}{(R+1)} x_D \tag{2}$$

Where Reflux Ratio, $R = L / D$ where the subscripts "n+1" and "n" are not shown Equation 2 is written in the form of Equation 3.

$$y = \frac{R}{(R+1)} x + \frac{1}{(R+1)} x_D \tag{3}$$

2.2.2 Feed section operating line (q-line)

The operating line for a feed tray considering the F moles/hr of feed, with fraction q of liquid, the liquid flow = q F moles/hr and vapour flow = (1-q) F moles/hr. The Feed section Operating Line (q-line) is given by Equation 4

$$y = -\frac{q}{(1+q)} x + \frac{1}{(1-q)} x_F \tag{4}$$

For a given feed condition, x_F and q are fixed; therefore the q-line is a straight line with slope $-q / (1-q)$ and intercept $x_F / (1-q)$.

If $x = x_F$, then $y = x_F$.

2.2.3 Stripping section

The operating line for the stripping section called Stripping Operation Line (SOL) as shown in Fig. 2 is given by Equation 5.

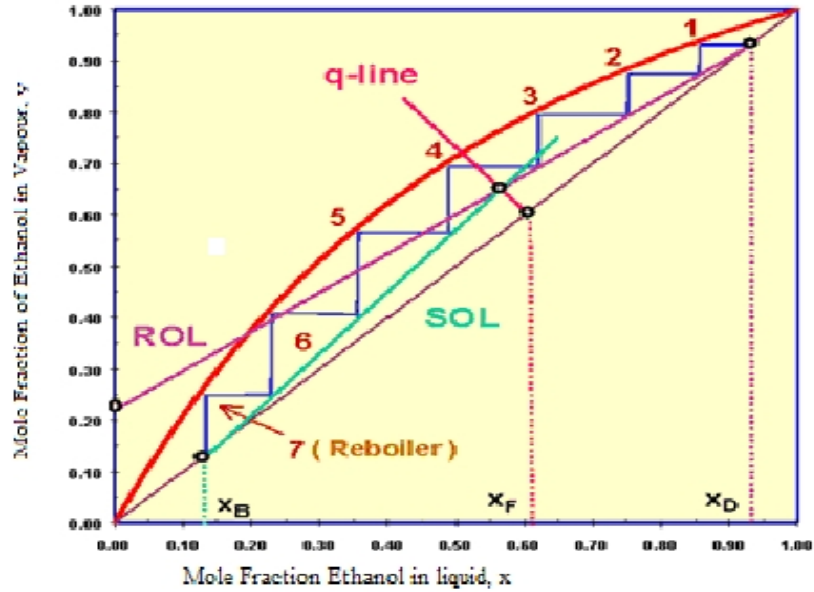

Fig. 2 Equilibrium curve for the binary mixture

$$y = \frac{L'}{(L'-B)} x - \frac{B}{(L'-B)} x_B \tag{5}$$

This is straight line with slope (L' / L' - B) and intercept (B x_B / L' - B)

2.2.4 Determination of number of trays

The Fenske Equation [7] given by Equation 6 was used to determine the minimum number of trays required for separation with the assumption of constant Relative Volatility (RV).

$$N_{\min} = \frac{\ln\left(\frac{x_D(1-x_B)}{x_B(1-x_D)}\right)}{\ln(\alpha_{AB})} \tag{6}$$

2.2.5 Minimum reflux ratio

The minimum reflux ratio was determined mathematically from the endpoints of the rectifying line at minimum reflux ratio using Equation 7.

$$R_{\min} = \frac{x_D - y'}{y' - x'} \tag{7}$$

2.2.6 Number of trays

Theoretical number of trays was determined using Gilliland [8] given by Equation (8).

$$\frac{N - N_{\min}}{N + 1} = 0.75 \left(1 - \left(\frac{R - R_{\min}}{R + 1} \right) \right)^{0.566} \quad (8)$$

2.3 Design Process and Validation

The process design software used for this work was developed using JAVA programming language hinged on McCabe -Thiele graphical method and Fenske equations to determine theoretical and actual number of stages involved in the distillation process.

The process design parameters such as Reflux Ratio (R), Coefficient of Reflux (R_{Coeff}), mole fraction of the most volatile component in distillate (x_D), mole fraction of the most volatile component in bottom (x_B), mole fraction of the most volatile component in feed (x_F), Viscosity, thermodynamic property of feed (q) were simulated for optimum values through parametric process. Reflux ratio was then varied to give the mechanical design parameters (Number of trays and column height).

A central composite experimental design was used to test the design software by varying the design parameters at five levels each. The experimental design allows the fixing of the lower and upper limits for each of the parameter tested. The parameters are R, RV, x_D , x_B , x_F while responses were Theoretical number of Trays in column (NT); Fenske Number of Trays; McCabe Number of Trays, Column height and the Efficiency of distillation column.

3. RESULTS AND DISCUSSIONS

The screen shot of the designed software is shown in Fig. 3 while Figs. 4, 5, and 6 depicts the input and output results of the effect of reflux ratio on number of trays when the values of reflux ratio was 3.094, 3.713, and 4.180 respectively as determined by the developed software at constant relative volatility. The same procedure was repeated for the values of reflux ratio of 5.733, 6.274, 6.819, 7.439, 7.984, 8.447, and 9.30 with the generated output shown in Table 1. The values shown in Table 1 were plotted to produce Figs. 7 and 8 which showed the effect of reflux ratio on number of trays and column height respectively.

The test results of the experiment showed that reflux ratio had a negative effect on the number of trays using the developed software as shown in Fig. 8; an increase in reflux ratio produced a reduction in number of trays and consequently the column height. This is not unexpected as using a higher reflux ratio results in less number of trays required.

Adelekan [9] in a research on ethanol productivity from cassava reported a similar observation in his study. A column with a high R may have fewer stages, but it refluxes a large amount of liquid, giving a wide column with a large holdup. Conversely, a column with a low R must have a large number of stages, thus requiring a taller column [10,11], this is evident in Fig. 8.

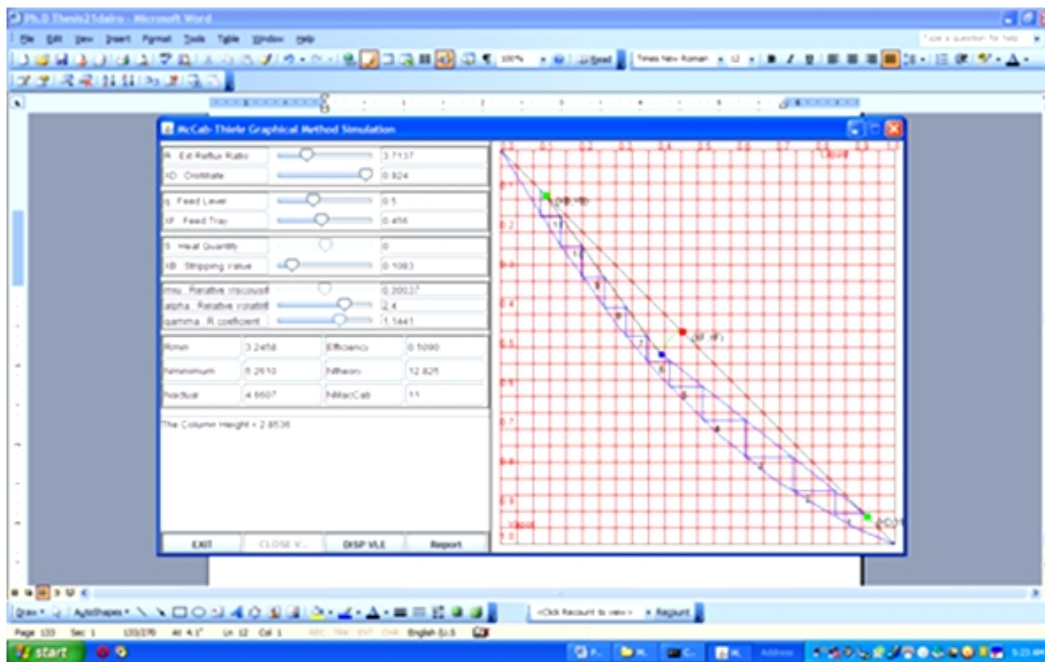

Fig. 3. A screen shot of a typical run of the design software

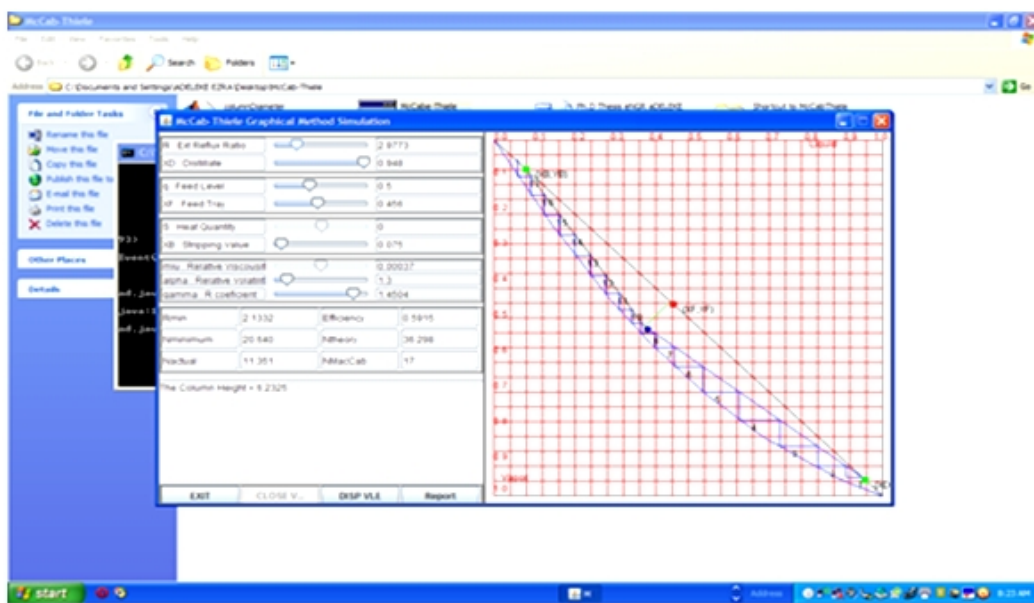

Fig. 4. Report of McCabe-Thiele graphical simulation of a distillation column at R=3.094

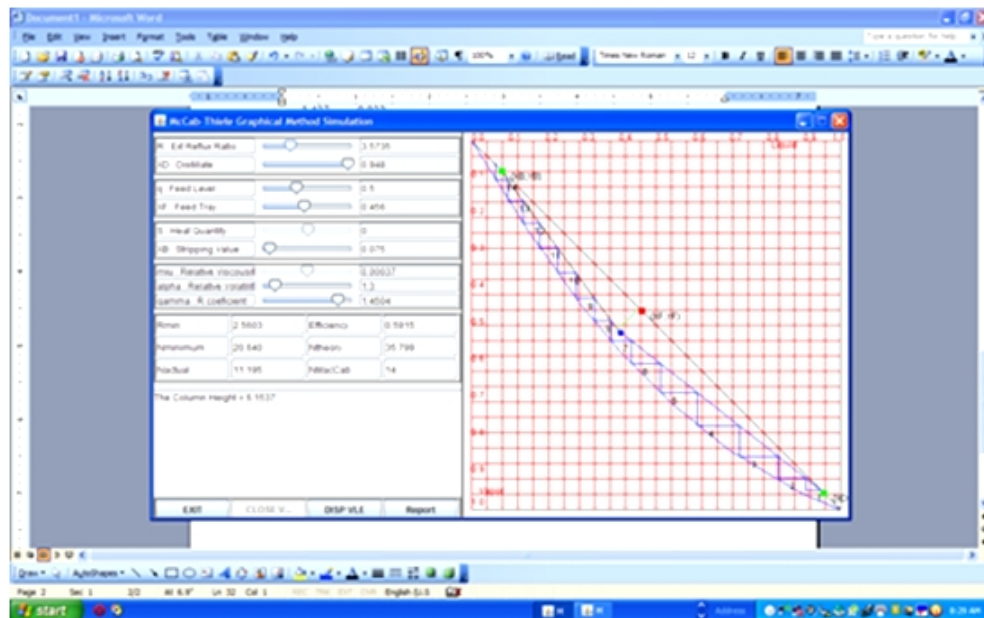

Fig. 5. Report of McCabe-Thiele graphical simulation of a distillation column at $R=3.713$

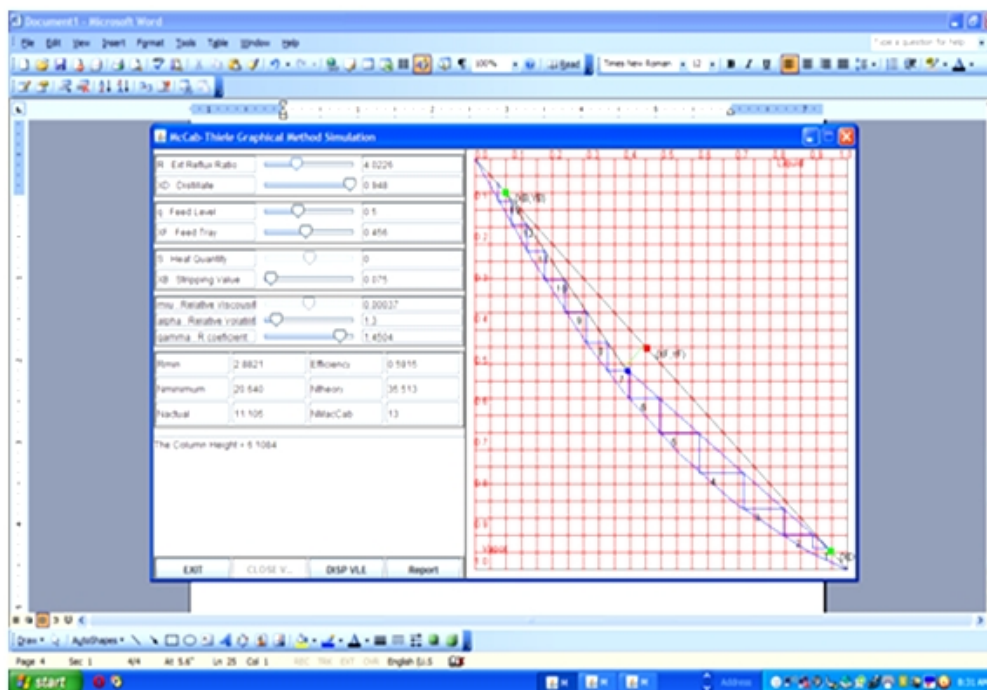

Fig. 6. Report of McCabe -Thiele graphical simulation of a distillation column at $R=4.180$

Table 1. Effect of Reflux Ratio on the theoretical number of tray at constant RV

Reflux Ratio	Minimum number of tray	Theoretical number of tray	Actual number of tray	McCabe number of tray	Column height(m)
3.094	21	36	11	17.0	6.232
3.713	21	36	11	14.0	6.153
4.180	21	36	11	13.0	6.108
5.733	21	35	11	11.0	6.007
6.274	21	35	11	11.0	5.983
6.819	21	35	11	11.0	5.962
7.439	21	34	11	11.0	5.942
7.984	21	34	11	10.0	5.927
8.447	21	34	11	10.0	5.915
9.301	21	34	11	10.0	5.897

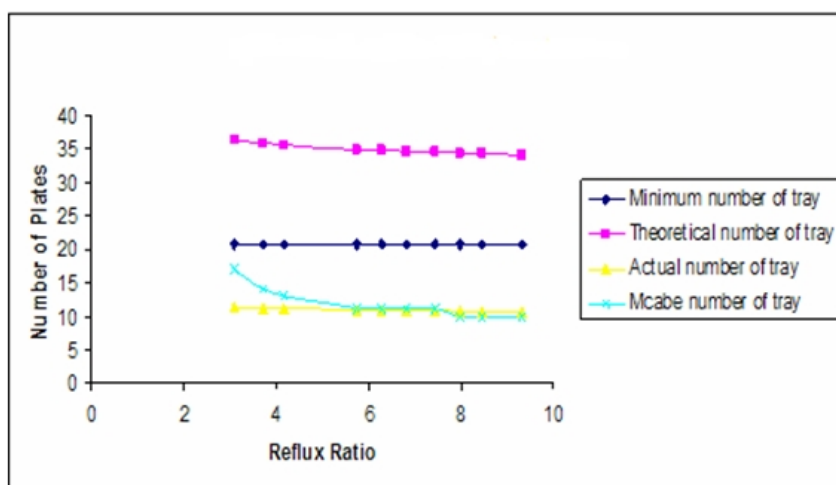

Fig. 7. Effect of Reflux Ratio on number of plates

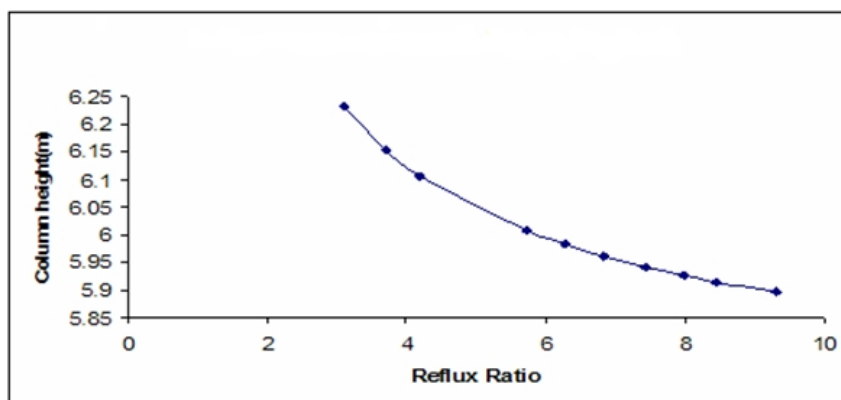

Fig. 8. Effect of Reflux Ratio on distillation column height

4. CONCLUSION

The use of the new simulation software revealed that Reflux Ratio (R) had a negative effect on the no of trays using both the Mc-Cabe and Fenske equations; an increase in reflux ratio produced a reduction in number of trays and consequently the column height.

COMPETING INTERESTS

Authors have declared that no competing interests exist.

REFERENCES

1. Ibrahim AM, Nassib AM, Abdel-Hafz OM, Bady MF. A study of the performance and exhaust emissions of spark ignition engine fuelled by ethanol-gasoline blends, Proceedings 3rd International Conference on Heat Powered Cycles, Cyprus, October; 2004.
2. Umar Garba M, Al Hassan M, Kovo AS. A review of advances and quality assessment of biofuels, Leonardo Journal of Sciences. 2006;9:167-178.
3. Gupta PK, Kumar R, Panesar BS, Thapar VK, Parametric studies on bio-diesel prepared from rice bran oil, Agricultural Engineering International: the CIGR Journal of Scientific Research and Development. 2007. IX(EE 06 007).
4. Wahoho S. Technology development in bio ethanol production in Indonesia” A power point presentation at the Asian Science and Technology Seminar, Japan Science and Technology Agency (JST) BPPT. Jakarta, March, 8th-9th;2007.
5. Oyewole O, Adebayo K, Sanni LO, Dipeolu AO, Ayinde IA. Development of the Small and Medium Scale Enterprise sector producing Cassava based products to meet emerging urban demand in West Africa. (2007). A final report on cassava SMEs project. University of Agriculture, Abeokuta.
6. Seader JD, Henley, Ernest J. Separation Process Principles. New York: Wiley. 1998 ISBN 0-471-58626-9.
7. Fenske MR. Ind. Eng. Chem. 1932;24:482.
8. Gilliland ER. Ind. Eng. Chem. 1940;32:1220.
9. Adelekan BA. Investigation of ethanol productivity of cassava crop as a sustainable source of biofuel in tropical countries. African Journal of Biotechnology. 2010;9(35):5643-5650.
10. Toliver TL, McCume LC. Distillation Column Control Design Based on Steady State Simulation, ISA Transactions. 1978;17(3):3-10.
11. Roat SD, Moore CF, Downs JJ. A steady state distillation column control system sensitivity analysis Technique. Proceedings IEEE Southeast Con; 1988:1-25.

© 2013 Adeleke et al.; This is an Open Access article distributed under the terms of the Creative Commons Attribution License (<http://creativecommons.org/licenses/by/3.0>), which permits unrestricted use, distribution, and reproduction in any medium, provided the original work is properly cited.

Peer-review history:

The peer review history for this paper can be accessed here:

<http://www.sciencedomain.org/review-history.php?iid=210&id=5&aid=1206>